

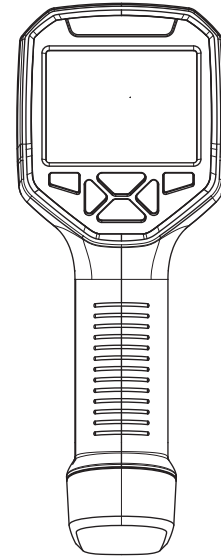

Thermal Imaging Camera Instruction Manual



Contents

Preface	1	3. Introduction to “Color Palette” Sub-menu	22
Limited Warranty and Limited Responsibility	1	3.1. Color Palette Description	22
Safety Instruction	3	3.2. Application of Color Palette	23
Preliminary Acquaintance with Infrared Thermal Imager	8	4. Introduction to “Emissivity” Sub-menu	24
Overview	9	4.1. Emissivity Description	24
Cleaning of the Products	10	4.2. Emissivity Setting	25
Lens Maintenance	10	4.3. The Emissivity Value of Common Materials	27
Charging of the Battery and Description	11	5. Introduction to “Setting” Sub-menu	28
Performance Index	12	5.1. Auto Shutdown Setting	29
Product Description	14	5.2. Intensity Settings	29
1. Instruction to Structure	14	5.3. Language Settings	29
2. Display Description	16	5.4. Unit Setting	29
3. Key Description	17	5.5. Time Format Setting	29
Initial Operation	17	5.6. Time Setting	30
Introduction to the Menu	20	5.7. Enable/disable of the Highest and Lowest Temperature Cursor	31
1. “Image Overlapping” Submenu	20	5.8. Wireless WIFI on and off	32
1.1. Description of Image Overlapping	20	Troubleshooting	35
1.2. Application of Image Overlapping	20	After-sale Service of the Product	35
2. Introduction to “Image” Sub-menu	21		
2.1. View Image	21		
2.2. Delete Images	22		

Preface

Respected users:

How are you! Thank you for purchasing our instrument. In order to use it in a better manner, we remind you to read the instruction for use carefully before use and keep it properly so as to look up in the future use.

Limited warranty and limited responsibility

MATRIX TECHNOLOGY INC. guarantees that the product enjoys warranty service of one year from the purchase date.

But the warranty is not applicable to fuse and disposable battery or the damage caused by improper operation, accidents, negligence, misuse, remodeling, pollution and abnormal condition of the operation environment. The distributor has no right to provide any warranty in the name of MATRIX TECHNOLOGY INC.

MATRIX TECHNOLOGY INC. authorizes the retail dealers to provide new products or unused products to final customers but does not authorize them to provide guarantee with wider scope or different contents. Only the products that are purchased through distributors authorized by MATRIX TECHNOLOGY INC. or products that the purchaser paid according to proper international price can enjoy the warranty support of our company. When the product bought in a country is sent to another country for repair, MATRIX TECHNOLOGY INC. reserves the right to charge the import fees for the parts and components to be repaired or replaced from the purchasers.

When warranty service is repaired, please contact the service center authorized by MATRIX TECHNOLOGY INC. to obtain the authorization information for return. Then post the product together with problem description to the service center with postage and insurance expenses prepaid. Our company will not undertake any responsibility for any damage occurred during the process of transportation. The product will be posted to the purchaser after repair with the transportation expenses paid by the purchasers.

If the product failure is verified by negligence, misuse, pollution, change, accidents or improper operation or handling after inspection, including the over voltage failure caused by use without following the rated value stipulated by the product or daily service wear the of the parts, our company will estimate the repair expenses and carry out repair after obtaining the consent of the purchasers. The product will be posted back to the purchaser after repair with the transportation expenses paid by the purchasers.

The guarantee is the only compensation that users can be obtained and does not include other express or implied guarantees. MATRIX TECHNOLOGY INC. will not undertake any responsibility for any special, indirect, accidental or subsequent damage or loss, including any data loss caused by any reasons or inference.

Because some countries or states do not allow implied warranties and incidental or consequential damages. Restrictions, so the above limitation of liability and regulations may not apply to every buyer.

The users shall make promise that they familiarize with the application field and occasi on. The purchase indicates that the users are deemed to know the suitability for the products.

Safety Instruction

Please ensure that you have read and understood the safety precautions described in the following text before using the product so that you can operate it correctly.

The safety precautions described in the following text guides you to operate the product and its accessories correctly and safely to avoid damage and loss to you, other people and the device.

Considerations

Please observe the following guide in order not to damage the product:

Don't assemble or dismantle the product without permission.

The product is a type of super precise equipment. Don't try to dismantle, assemble or remodel any part of the product. Repair of the product should be made by technical personnel designated by MATRIX Company.

Avoid damage to probe of the product

Note: don't put the product close to strong heat source directly (such as electric iron). Otherwise, it may damage the probe of the product.

Product hum

When the product works, there is light sound of clicking every several seconds. This is normal phenomenon that the lens captures images.

Warning

The warning describes the acts that may cause harm to users. Please observe the following operation in order to avoid electric shock or personal injury.



Warning: Don't aim the laser pointer at human or animal's eyes. The laser given out by the laser pointer may harm the vision.

- **If the product case is damaged, don't use it continuously.**

Please contact the local distributors or agents of MATRIX under such condition.

- **During the process of use, if the product is found with smoke, spark and the burnt smell, please stop using at once.**

In case of such condition, the product power supply should be powered off first. After the smoke and peculiar smell disappears completely, please contact the local distributors or agents of MATRIX.

- **Don't remodel the adapter and the data line.**

Otherwise, such remodeling may cause short circuit or fire.

- **Don't weld the battery without permission.**

Such operation may damage the battery and result in leakage and explosion of the battery.

- **Avoid that the battery is impacted (such as collusion and falling, etc).**

Such condition may damage the battery case or result in that the battery leaks or explode.

- **Please pull off the adapter on the power socket when charging is not made.**

The adapter may get overheated if it is connected with power supply for a long time. This may cause overheating, deformation and fire.

- **Please ensure that the plug of the adapter is inserted into the specified power socket.**

The adapter plug may be different due to the regions. Please make confirmation whether the specification of the adapter is consist with the specification of electric appliances in your region. Otherwise, this may cause overheating of the equipment, electric shock, fire, chemical leakage inside the battery, explosion and other serious consequences.

- **When the plug of the adapter or wire is damaged, stop using immediately.**

Don't change the battery unless the plug of the charger is inserted into the socket completely.

- **Do not touch the electric wire with wet hands.**

It is possible to cause electric shock when touching the electric wire with wet hands. When pulling out the electric wire, hold the electric wire head rightly to pull out the wire. Don't pull off the electric wire directly. Otherwise, the electric wire may be broken, causing electric shock and fire.

- **Forbid dip the product into water caught in rain.**

If the case contact with any liquid, please wipe it dry immediately. If water or other liquid enters the inside of the instrument, please power off the power supply at once. Continuous use may result in product damage.

- **Clean the dust on the adapter plug and the data line.**

When it is exposed to dusty and dump environment for a long time, the dirt surrounding the electric equipment will accumulate moisture. This may cause short circuit and fire.

- **Please use the original adapter of the company to charge the product.**

The use of non-original power supply accessories may cause equipment overheating, electric shot, fire, and leakage of chemicals inside the battery, explosion and other serious consequences.

- **Don't use abrasant, isopropanol or solvent to clean the enclosure of the device.**

Such operation may cause the product case to be damaged.

- **The product temperature may increase after a long time of charging.**

You may feel scorching heat when the hands touch the sensors.

- **Problem caused by water condensation**

Don't bring the instrument into low temperature environment from high temperature environment in a short time or from low temperature environment to high temperature environment. This may result in that the inside of the instrument and appearance produce water condensation. In such condition, the instrument should be placed into portable box or plastic bag. Before use, make it restore to the environmental temperature and take it out to use.

If the product has water condensation inside, please power it off immediately. Otherwise, the instrument may be damaged. Operation is not allowed unless the water condensation disappears.

- **Avoid that the product is impacted (such as collision and falling, etc).**

Such operation may cause the product to be damaged. Please avoid such operation.

- **Long-time storage and regular charging.**

The product should be placed at a cool and dry environment if it not used for a long time. If the product installed with battery is stored for a long time, charging should be made regularly. Otherwise, the battery will run out and the service life will be shortened.

Preliminary Acquaintance with Infrared Thermal Imager

For a long time, infrared thermal imaging detection technology has become an important means to ensure Industrial safety in developed countries. The application field includes electric power, metallurgy, petro-chemistry, machinery, coal, traffic, fire control and national defense, etc. It can not only carries out real-time detection at high voltage, high current and high speed operation to perform real-time detection for production and instrument but also need not power off the power supply, stop the machine or stop the production to find the potential problems and prevent occurrence of malfunction. The "non contact" modern detection technology is safe, reliable and quick. It is a type of technical revolution compared with traditional contact detection method.

The infrared thermal imaging technology is widely used in the following fields:

- Power equipment, transmission, transformer line inspection;
- Hidden fire source search in fire protection;
- Personnel search and rescue in the fire, and fire command;
- Analyze the location and heat loss of leak points in heat pipes and heating equipment;
- Determining the location of the heating fault of the operating train;
- Security department night monitoring.

Overview

This product is an infrared camera that integrates surface temperature measurement and real-time thermal image. The traditional inferred thermometer needs to measure every component one by one while it is not necessary for infrared imaging camera, thus saving time. The potential problems may be displayed on color display screen clearly. Moreover, the central point measurement cursor is used to locate quickly and accurately to measure the temperature of the target object.

In order to increase the differentiation, the product is provided with a visible light camera. The thermal images and visible images are stored in the device and can be read through USB or stored in a computer to generate a report or for print.

With small volume, the product is easy to operate and has strong function. it is the ideal selection for electric power, electronic manufacturing, Industrial inspection and other fields.

The following major functions increase the product's accuracy and usability:

- The radiation coefficient may be adjusted to increase the measurement accuracy of objects with half reflection surface.
- The highest temperature and lowest temperature cursor may guide the users to the areas with highest and lowest temperature of the thermal images.
- The selectable color palette.

Cleaning of the Products

Please use damp cloth or weak soap to clean the enclosure of the device. Don't use abrasant, isopropanol or solvent to clean. The lens and screen should be cleaned with use of cleaning agents for professional optical glasses.

Lens Maintenance

Prevent damage of the infrared lens:

- Clean the infrared lens carefully. The lens is provided with refined anti-reflection coating.
- Don't clean with force to prevent damage of the anti-reflection coating. The selectable color palette.
- Use a cleaning solution for lens maintenance, such as alcohol-based commercial lens cleaners, alcohol, and a lint-free cloth or paper towel. Compressed air tanks can be used to remove loose particles.

Clean the lens:

- The compressed air tank or dry nitrogen ion gun (if applicable) may be used to blow the loose particles on the lens surface.
- Dip the lint free cloth in alcohol.
- Squeeze the excessive alcohol in the cloth or apply the lint free cloth on dry cloth lightly.
- Wipe the lens surface by making circular motion. Then discard the cloth.
- If it is necessary to repeat above step, please use new cloth to dip with the cleaning solution to wipe.

Charging of the Battery and Description

Use USB data line to charge:

- The product has built-in chargeable 26650 lithium batteries.
- When the battery level is low, the top right of the screen will display “  ”.Please charge in time through Micro USB interface.
- Pull off the USB line after fully charging.

Note: When the battery is completely empty, there will be an abnormality. It is recommended to use the battery when it is sufficient.

To make the lithium ion battery can play the perfect performance:

- Don't place the battery on the charger exceeding 24 hours.
- The thermal imaging device should be charged for two hours at least every three months so as to extend the battery service life to the greatest extent.
- Don't try to charge the battery in extremely cold environment.

Performance Index

Model	MTM-601
Display screen	3.5-inch full-view TFT display
Infrared image resolution	320×240
Visible image resolution	300000pixel
LCD resolution	640×480
Field angle	56°×42°
Thermal sensitivity	0.07°C
Frame rate of thermal images	9Hz
Focus mode	Fixed
Wavelength coverage	8-14um
Emissivity	Adjustable from 0.01 to 1.00
Color palette	Rainbow, iron oxide red, cold color, black & white, white & black
Temperature measurement range	-20°C~450°C (-4°F~842°F)
Measurement accuracy	≤100°C ±2%; 100—300°C ±2%; ≥300°C ±3%; ≥400°C ±10%

Storage capacity	Built-in 8G (Actually available 6.6G)
File format	JPG
USB	Micro USB 2.0
Power supply	Built-in chargeable 26650 battery Detachable
Working time	3-4 hours
Setting command	Unit、 language、 date、 time、 information
Language	English、 Chinese、 Italian、 German
Automatic power-off time	Selectable: 5 minutes/20 minutes/ not power off automatically
Product size	256mm×97.2mm×128.9mm
Product weight	588g
Work temperature	0°C to 45°C
Storage temperature	-20°C to 60°C
Relative humidity	< 85%RH

Product Description

1. Instruction to Structure

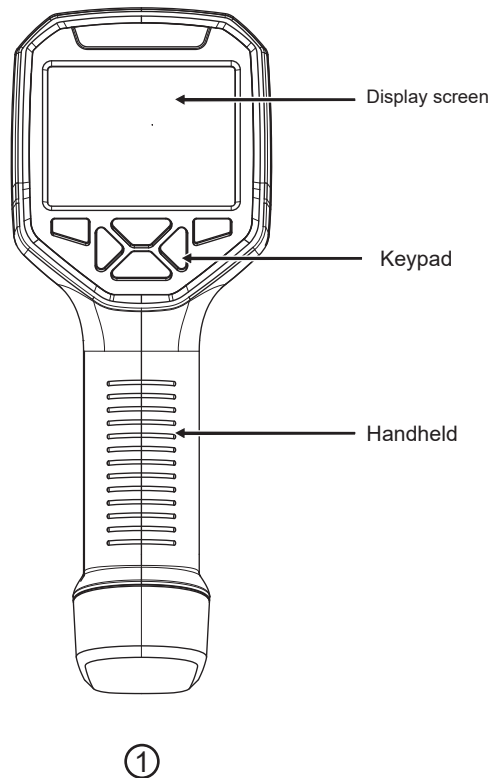

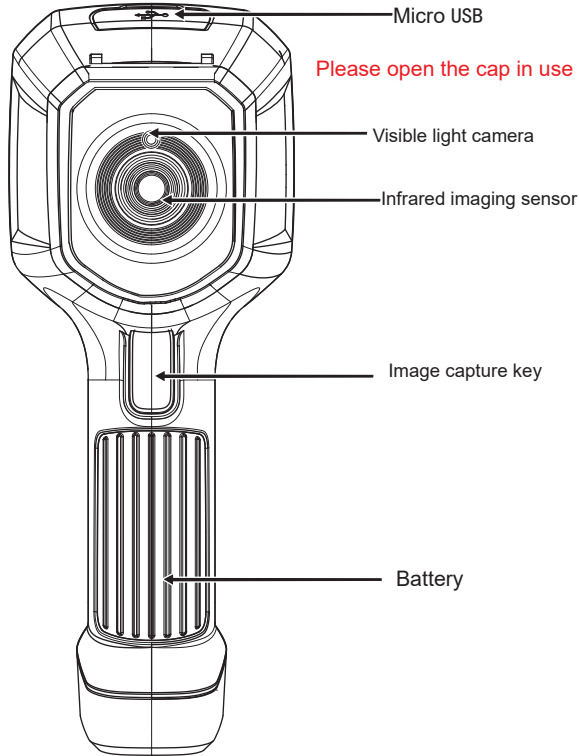

②

2. Display Description

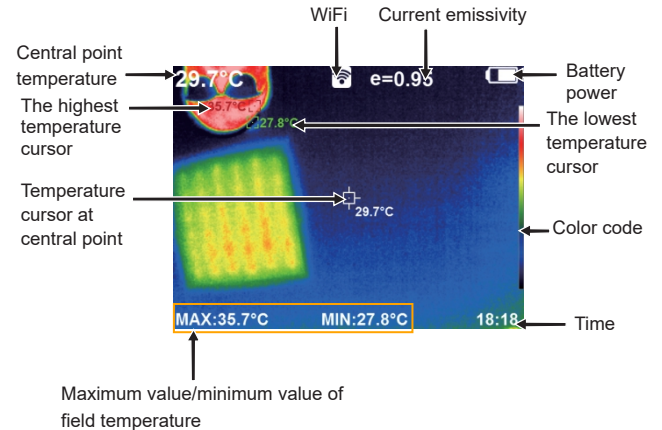

Color code: used to mark the color corresponding to the relative temperature from low to high in the field of version.

The central point temperature cursor: used to indicate the central position in the screen area. The cursor color displays white. The temperature value is displayed top left corner of the screen.

The highest temperature cursor: used to indicate the highest temperature position in the screen area. It will move with the movement of the highest temperature. The cursor displays red. The temperature value is displayed at bottom left corner of the screen.

The lowest temperature cursor: used to indicate the lowest temperature position in the screen area. It will move with the movement of the lowest temperature. The cursor displays red. The temperature value is displayed at the central position of the screen.

3. Key description

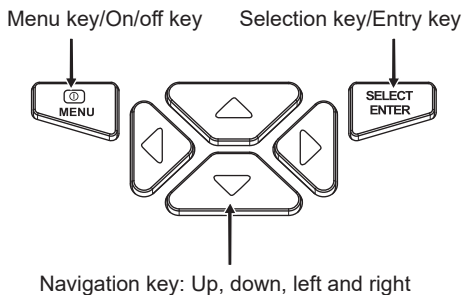

Initial Operation

- Product boot/shutdown

Press and hold the “ ⏻ / MENU ” button for more than 3 seconds to turn the Thermal Imaging on or off.

- LCD screen display

After turning on the power, the screen shows the thermal imaging status.

Note:

Time adjustment may be required when you move the camera between environments with widely varying ambient temperatures.

- Switching between infrared thermal image and visible image

press “ ◀ ” or “ ▶ ” key to switch the degree of fusion between infrared thermal images and visible images (the degree of fusion is 0%, 25%, 50%, 75% and 100%).

- Image capture

Press the image capture key. When the capture is successful, the screen will display “save photo?” prompt. Select “Yes” or “No” to delete the image, press the “ ◀ ” “ ▶ ” button to Switch the selection, then press the “SELECT/ENTER” button to confirm. Yes, you can press the capture button again if you are sure to save the image.

- The function to hide highest/lowest temperature column at the screen bottom

under the operation after normal start up, press “ ▲ ” key and the screen bottom will display highest/lowest temperature column.

Press “ ▲ ” can also hide it.

- Image output

The saved images through capture may be checked and output by connecting with a computer through Micro USB.

- Read images

Open the USB protective cover as shown in ② . Use USB line to connect the USB port and then computer to read the images or save it into computers.images or save it into computers.

The supported operating system through verification includes: winxp, win7, win 8, win10, Apple system.

It is suggested to use the attached USB line or USB line with higher quality.

Note:

When connecting with a computer, pull off the data line after selecting “pop out device safely” to avoid causing file system damage and other problems. If “unable to save” and other problems occur, you may find the hard disc in the computer and fix it.

Introduction to the Menu

Press the left of “ ⏻ /MENU ” key and the menu bar appears. They are “Image overlapping”, “Image”, “Color palette”, “Emissivity” and “Setting” submenus.

1.“Image Overlapping” Submenu

1.1. Description of Image Overlapping

Image overlapping makes it easier for users to understand the infrared images by using aligned visible images and infrared images. The use of image overlapping can capture the visible image of every infrared image so as to display the temperature distribution in the target region correctly and share with other people more effectively.

1.2. Application of Image Overlapping



Press the “ ⏻ / MENU ” button to enter the main menu, and select “  ” (Image registration) in the main menu.

Press the “ SELECT/ENTER ” button to enter the image overlap adjustment mode.Press the navigation keys (up, down, left and right buttons) to perform the visible image shift operation.





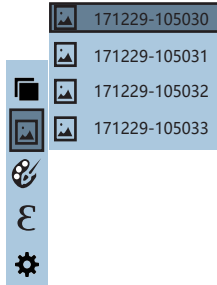

Press the “SELECT/ENTER” button to exit the image blending mode (Note: If there is no operation for more than 6 seconds, the image blending mode will be automatically exited).

2. Introduction to “Image” Sub-menu





2.1. View Image

Press the “  / MENU” button to enter the main menu, and select “  ” (image) in the main menu.



As shown in the figure, Then press “  ” key to enter image list.
Press “  ” or “  ” key in navigation to select the image. Then press “SELECT/ENTER” key to view image.
When viewing the images, press “  ” key to view the previous image, Press “  ” to view the next image.
Press “ SELECT/ENTER ” key to return. Press “  /MENU” key to exit from the menu.

2.2. Delete Images

While viewing the image, press the “  ” button, the screen will display “Delete photo?” Select “Yes” or “No” to delete the image, press the “  ” “  ” button to Switch the selection, then press the “SELECT/ENTER” button to confirm. When the image is deleted, “No Image” will be displayed. Press “SELECT/ENTER” to return to the menu and press “  /MENU” to exit the menu.

3. Introduction to “Color Palette” Sub-menu

3.1. Color Palette Description

The palette can be used to change the pseudo-color display of the infrared image on the display. Some tune Swatches are better suited for specific applications and can be set up as needed. The palette is divided into: rainbow, iron red, cool, white hot, black hot, five palettes. These palettes work best with high thermal contrast and provide additional color contrast between high and low temperatures.

Suitable selection of color palette displays the details of the target objective better. Rainbow, iron oxide red and cold color palettes focus on display of color. Such color palettes are very suitable for high heat contrast and are used to improve the color contrast between high temperature and low temperature. But the black & white and white & black color palettes provide even linear color.

The following is the image of the same object with selection of different color palettes.

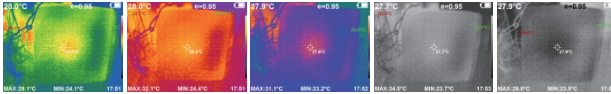

Rainbow Iron oxide red Cold color White heat Black heat

3.2. Application of Color Palette

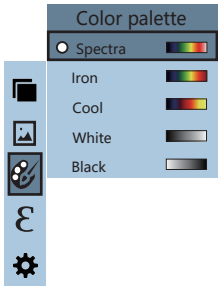

As shown in the figure, press “ \mathcal{U} /MENU” key to enter the main menu and select “ \mathcal{C} ” (color palette) option and press “ \blacktriangleright ” key to enter the color palette list. Press “ \blacktriangle ” and “ \blacktriangledown ” keys in navigation to select the color palette. Then press “SELECT/ENTER” key to select the color palette. Press “ \blacktriangleleft ” to return. Press “ \mathcal{U} /MENU” key to exit from the menu.

4. Introduction to “Emissivity” Sub-menu

4.1. Emissivity Description

The emissivity of the product can be adjusted from 0.01 to 1.00 with the default value of 0.95. Many common objects and materials (such as timber, water, skin and textile fabric) can reflect the heat energy effectively. So it is easy to obtain relatively correct measurement value. The emissivity is usually set as 0.95 when the coarse objects that are easy to give out energy. For semi-matte objects that give out less energy, the emissivity is usually about 0.85 and the emissivity of semi-gloss objects is 0.6. The shiny objects are divided into materials with low radiation coefficient. The emissivity is usually set as 0.3 at the time of measurement. Correct setting of the value of emissivity is very important for you to carry out the most correct temperature measurement. The surface emissivity will produce giant impact on surface temperature measured by the product. Understanding the surface emissivity will enable you to obtain correct temperature measurement result.

4.2. Emissivity Setting

The product is provided with four types of object measurement modes:

- Coarse object (0.95)
- Semi-matte object (0.85)
- Semi-shiny object (0.60)
- Shiny object (0.30)

According to the characteristics of the measured objects, users may set the emissivity value through the "self-define" option (please refer to the table of "emissivity of common materials").

The operating step is as the following:

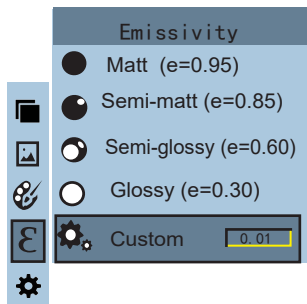

As shown in the figure, press " \mathcal{U} / MENU" key to enter the main menu and select " \mathcal{E} "(emissivity) option and press " \blacktriangleright " key to enter the emissivity list.



Press " \blacktriangle " and " \blacktriangledown " keys in navigation key to select the emissivity. Then press " SELECT/ENTER" key to determine selection of the emissivity. Press " \blacktriangleleft " key again to return.









If you select "self-defined" emissivity, press the " SELECT/ENTER " button to enter the editing state. Press " \blacktriangleleft " / " \blacktriangleright " keys to select the number to be changed, press " \blacktriangle " " \blacktriangledown " keys to change the value. After the modification is completed, press " SELECT/ENTER" to confirm, then press " \blacktriangleleft " to return. The " \mathcal{U} / MENU" button exits the menu.

4.3. The Emissivity Value of Common Materials

Substance	Thermal radiation	Substance	Thermal radiation
Bitumen	0.90~0.98	Black cloth	0.98
Concrete	0.94	Human skin	0.98
Cement	0.96	Foam	0.75~0.80
Sand	0.90	Charcoal dust	0.96
Earth	0.92~0.96	Paint	0.80~0.95
Water	0.92~0.96	Matte paint	0.97
Ice	0.96~0.98	Black rubber	0.94
Snow	0.83	Plastic	0.85~0.95
Glass	0.90~0.95	Timber	0.90
Ceramics	0.90~0.94	Paper	0.70~0.94
Marble	0.94	Chromium hemitrioxide	0.81
Gypsum	0.80~0.90	Copper oxide	0.78
Mortar	0.89~0.91	Ferric oxide	0.78~0.82
Brick	0.93~0.96	Textile	0.90

5. Introduction to “Setting” Sub-menu

Press “  /MENU” key to select the “  ”(setting) option in the main menu. Press “  ” key again to enter the “setting” sub-menu.

Settings		
	Auto shutdown ▶	Auto shutdown NO 5min 20min
	Intensity ▶	Intensity Low Medium High
	Language ▶	Language English Chinese Italian German
	Unit ▶	Unit Celsius Fahrenheit
	Time format ▶	Time Format 24 hour AM/PM
	Set time ▶	Set time Year 2019 Month 09 Day 18 Hour 15 Minute 15 Second 15
	Spot ▶	Spot Off On
	WiFi ▶	WiFi Off On

5.1. Auto Shutdown Setting

After entering the "Settings" sub-menu, select " ⏻ / MENU" (automatic shutdown), press navigationThe " ▶ " button in the button enters the auto power off setting. Can be set to not automatically shut down or 5 points The clock is turned off or turned off in 20 minutes.

5.2. Intensity Settings

After selecting " 🌞 " (brightness), press the " ▶ " button in the navigation key to enter the brightness setting. Can be set to low or medium or bright.

5.3. Language Settings

After selecting " 🌐 " (language), press the " ▶ " button in the navigation key to enter the language setting.

Available in 4 languages: English, Chinese, Italian, German.

5.4. Unit Setting

After selecting " °C " (unit), press the " ▶ " button in the navigation key to enter the temperature unit setting. Can be set to Celsius or Fahrenheit.

5.5. Time Format Setting

After you select " 24🕒 " (time format), press the " ▶ " key in the navigation key to enter the time format setting. Can be set to 24 hours or 12 hours.

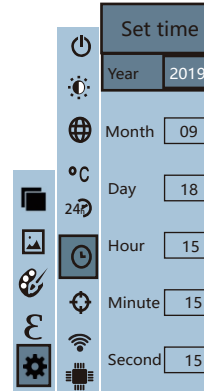

5.6. Time Setting

As shown in the figure, after selecting " ⌚ " (set time), press " ▶ " in the navigation key to enter the setting time.







- Press " ▲ " / " ▼ " to select year/month/day/hour/minute.
- After selecting, press "SELECT/ENTER" key to enter the edit state.
- Press " ◀ " and " ▶ " keys to select the figure to be changed. Press " ▲ " / " ▼ " key to change the value. After completing the change, press " SELECT/ENTER" to enter.
- After the time setting is completed, press " ◀ " key to return. Press " ⏻ / MENU " exit from the menu.

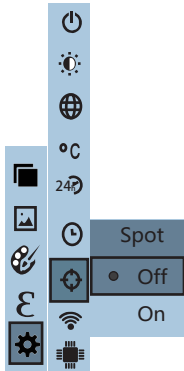

5.7. Enable/Disable of the Highest and Lowest Temperature Cursor

As shown in the figure, after selecting “” (cold hotspot), press the “” button in the navigation key to enter the cold hotspot setting.





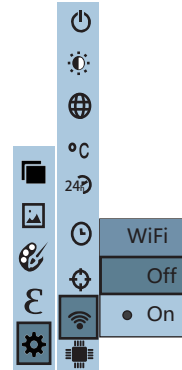

- Press “” / “” key to select “enable” or “disable” the option.
- Then press “SELECT/ENTER” key to determine selection.
- After the setting is completed,press “” key to return. Press “ / MENU” key to exit from the menu.

5.8. Wireless WIFI on and off

As shown in the figure, after selecting “” (WiFi), press the “” button in the navigation key to enter the WIFI setting.



- Press “” / “” key to select “ON” or “Off” the option.
- Then press “SELECT/ENTER” key to determine selection.
- After the setting is completed,press “” key to return. Press “ / MENU” key to exit from the menu.

After enabling WIFI, use the mobile device to search for WIFI. The hotspot name is ThermalCamera-xxxxxx (xxxxxx is the last six digits of the MAC); access the device through the IP address 192.168.230.1.

In the mobile device, you can set the color palette, blending degree, emissivity, maximum/minimum value, language conversion, and synchronize to the machine. The settings on the machine can also be synchronized to the mobile device (Note: if not converted, on the mobile Refresh on the device). Click on the photo on the mobile device and the image is saved on the machine as shown below.

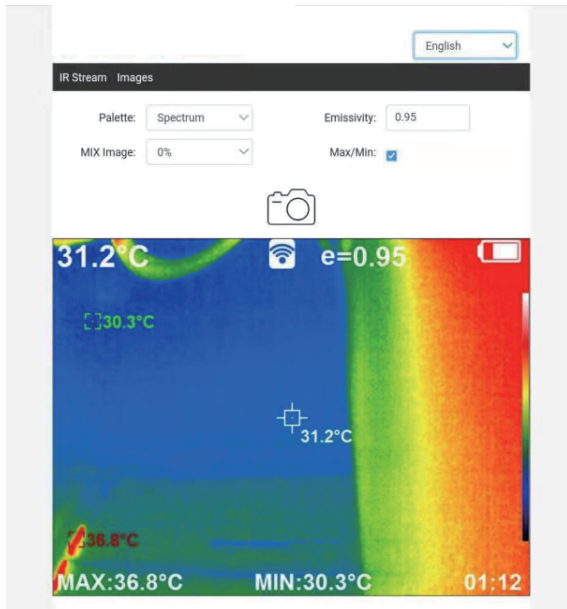

Click "Image" in the mobile device to enter the image view, press the image to download the image, long press the image to save to the mobile device, click "Infrared Video Stream" to return to the video stream webpage, as shown below.

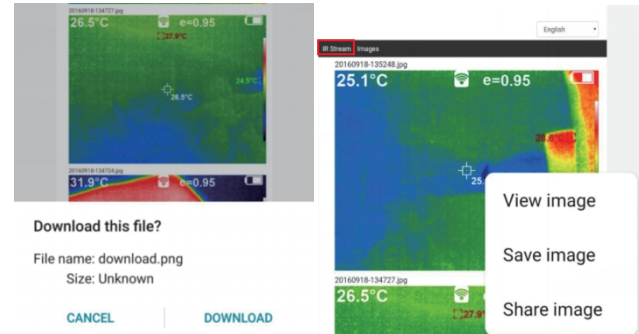

Troubleshooting

If you encounter with any problem when using the thermal image device, please use the following table for repair. If the problems are not solved, please cut off the power supply and contact with the manufacturer.

Failure phenomenon	Failure cause	Solution
The thermal imaging device cannot start	The battery is not installed	Install the battery
	The power of the battery is used up	Replace with new battery or charge it
The thermal imaging device powers off automatically	The power of the battery is used up	Replace with new battery or charge it
	The time set for automatic power off is due	Restart or change the time for automatic power off after restarting (refer to 5.1)

The following conditions are not within the warranty scope:

1. Unable to show the original of effective warranty voucher.
2. The product installation does not comply with product requirements and relevant specification, which causes damage;
3. The damage is caused due to that users use and store it improperly or dismantle and repair it without permission and other reasons;
4. Damage caused by natural disasters (earthquake, flood and lightning stroke) and external disasters;
5. Exceed the warranty period.

Considerations:

1. If the product malfunction, repair or replacement with new or good product is made according to the condition after the product is inspected.
2. For product exceeding the warranty period, determine whether to repair or replace the part after inspection for the product is performed. Relevant expense will be charged for all types of repair and replacement of parts and components according to actual condition.

After-sale Service of the Product

Respected customers:

Thank you for purchasing the product of our company. The product carries a warranty period from the date of sale.

During the warranty period of the product, if installation and use is made according to the user manual at normal environment and conditions, users may enjoy free repair service by warranty voucher for faulty product caused by raw materials and manufacturing process. The warranty voucher should be kept properly by the users and will not be reissued if lost.

In order to avoid problems during the use process, our company suggests that you familiarize with the user manual of the product first before the product is used.